

# User manual

Original instructions for Somnox 2: Breathe & Sleep Robot

# Table of contents

Safety	3	<b>Sleeping with your Somnox 2</b>	29
Product specifications	7	Preparing for bed	29
		Positioning	30
		Midnight awakening	31
		Tips for using your Somnox 2	31
<b>Welcome to the Somnox family</b>	8		
Take your time to get adjusted to Somnox 2	8		
How does Somnox 2 work?	9		
		<b>Use your Somnox 2 during the day</b>	32
<b>An overview</b>	10		
What comes with the Somnox 2 package?	10	<b>Cleaning your Somnox 2</b>	33
An overview of Somnox 2	11	Washable sleeve	33
An overview of the Button panel	11	Drying your Somnox 2	34
<b>Getting started</b>	12	<b>Troubleshooting</b>	35
Charging Somnox 2	12		
Basic functionalities	14	<b>Contact information</b>	36
Download the mobile app	15	Feedback	36
<b>The mobile app</b>	16	<b>Certification</b>	37
Create an account & sign in	16		
Connecting your Somnox 2 with the app	17		
Overview of the app	18		
Breathing-menu	19		
Sound-menu	21		
Status bar	22		
<b>Updating your Somnox</b>	23		
Setting up Wi-Fi for iOS	25		
Setting up Wi-Fi for Android	26		
What is a 2.4 GHz network?	27		

# Safety

**The safety instructions below should be adhered to at all times. Please read them carefully before use, as misuse may result in damage to the device or other property, serious injury or even death.**

## General

Do not insert foreign objects into any opening of the device, such as the power adapter port.

Do not drop, smash, disassemble, open, crush, bend, deform, puncture, shred, microwave, incinerate or paint the device or powered accessories. Exposure of internal components can cause damage to both yourself and your surroundings.

## Sound and Hearing

To prevent possible hearing damage, do not listen at high volume levels for long periods of time. Listening to sound at high volumes or for long periods may damage your hearing.

## Fire / Heat



Do not place naked flames, such as lighted candles, cigarettes and cigars on or near the product. The device or the battery may explode when overheated and exposed to an extreme heat source, such as a fire. Stop using the device if it starts to overheat.

Do not expose your device to heavy smoke or fumes as these may contaminate internal components.

Prolonged heat exposure of the device and its power adapter comply with applicable surface temperature

standards and limits. However, even within these limits, sustained contact with warm surfaces for long periods of time may cause discomfort or injury. Take special care if you have a physical condition that affects your ability to detect heat against the body.

## Water



Do not touch the button panel of the device, cords, plug, charger, battery, or other internal components with wet hands. Doing so may cause an electric shock to you or damage to the device's components.

Keep the device dry. Precipitation, humidity, and liquids contain minerals that can corrode electronic circuits. We recommend the device should always be used in conjunction with a sleeve to minimize the impact on the device.

Do not use the device if you are incontinent or if you have any other condition where there is a chance of wetting the device. This could cause fire, electric shock, injury, or damage to the device or other property.

Do not turn on your device if it is wet. Should it become wet while already switched on, immediately turn off your device and allow it to dry. Follow the proper drying recommendations outlined in your manual and DO NOT accelerate drying with the use of, for example, an oven, microwave, or (hair)dryer, because this may damage the device and could cause a fire or explosion.

### Not a medical device



This product is not designed or intended for use in the diagnosis of diseases or other conditions, or in the cure, mitigation, treatment, or prevention of disease. Consult your physician for prevention, diagnosis, and treatment of sleep disorders and other medical issues.

The device contains components and radios that emit electromagnetic fields. The device also contains magnets. These electromagnetic fields and magnets may interfere with pacemakers, defibrillators, or other medical apparatus. Maintain a safe distance between your medical apparatus and Somnox 2. Consult your physician and medical apparatus manufacturer for information specific to your medical apparatus. If you suspect Somnox 2 is interfering with your pacemaker, defibrillator, or any other medical apparatus, stop using the device.

If you have a medical condition or experience symptoms that you believe could be affected by Somnox 2, consult your physician prior to using the device.

### Parts / attachments / accessories



Only use parts, attachments and accessories specified by Somnox (see: [www.somnox.com](http://www.somnox.com)).

Do not install other software than Somnox-approved software (for example: viruses or potentially harmful software) on the device. This may result in malfunction, security breaches or serious injury.

For the purposes of recharging the battery, only use the detachable supply unit (charger model MKC-0502000DEXU) provided with this appliance. Only Somnox-approved chargers may be used to charge the device. Other adapters may not meet applicable safety standards. Charging with non-approved chargers may affect the performance of the device and poses a possible risk of fire or explosion, which could lead to serious bodily injury or damage to the device or other property. Somnox 2 contains batteries that are non-replaceable.

### Battery

Do not allow leaking battery fluid to come into contact with your eyes, skin or clothing.

### Charging

Do not use the device while charging, as this could result in suffocation, electrical shock, injury or death, for example by the charging cable becoming wrapped around a user's neck while sleeping.

Do not place the charging cable in bed (attached or unattached to the appliance). This could lead to suffocation or other injury.

Do not charge the device in a sealed or badly ventilated environment, like under a blanket or in a poorly-ventilated room. Charging under these circumstances may affect the performance of the device and poses a possible risk of fire or explosion, which could lead to serious bodily injury or damage to the device or other property.

Using damaged cables or chargers, or charging when moisture is present, can cause fire, electric shock, injury, or damage to the device or other property. If the supply cord is damaged, it must be replaced by a special cord or assembly available from the manufacturer.

When you charge the device, make sure the cable is fully inserted into the power adapter before you plug the adapter into a power outlet.

Unplug the device during lightning storms or when unused for long periods of time.

Protect the power cord from being walked on or pinched, particularly at plugs, convenience receptacles and the point where they exit the apparatus.

**Children / persons with reduced physical, sensory, mental capabilities**



This appliance is not intended for use by persons (including children) with reduced physical, sensory or mental capabilities, or those lacking experience and knowledge, unless they have been given supervision or instruction concerning use of the appliance by a person responsible for their safety.

Children should be supervised to ensure that they do not play with the appliance.

Do not use the device with infants or children from 0 up to and including 3 years old. This could cause suffocation, electrical shock or injury to the child.

This appliance may be used by children older than 3 years and younger than 8 years, only if they're under continuous supervision.

The appliance may be used by children aged 8 years and above, and persons with reduced physical, sensory or mental capabilities, or lacking experience and

knowledge, only if they have been given supervision or instruction concerning use of the appliance in a safe way and understand the hazards involved. Children shall not play with the appliance. Cleaning and user maintenance shall not be carried out by children without supervision. Children or other persons requiring supervision can accidentally choke on small device components or parts, especially if these have broken off.

**Damage**



Protect the device, battery, and other components from damage. Handle the device with care. Do not use the device if it is damaged.

Do not disassemble the device or power adapter yourself or allow an unauthorized party to do so.

If you suspect damage to the device or battery, contact Somnox for inspection. There are no repairs that you can safely carry out yourself. Refer all servicing to qualified servicing personnel. Servicing is required when the apparatus has been damaged in any way, such as when the plug is damaged, liquid has been spilled, or the apparatus does not operate normally or has been dropped.

Failure to properly set up, use, and care for this product can increase the risk of serious injury, death, property damage, or damage to the product or related accessories.

## Environment



Do not expose your device and its components to extreme heat or cold. The device can be used safely in locations and environments with temperatures between 0°C / 32°F and 35°C / 95°F. Avoid prolonged exposure of your device to temperatures below 0°C / 32°F or above 45°C / 113°F. Using your device for prolonged periods outside the recommended safety ranges can damage the device and reduce the storage capacity and lifespan of its battery. Do not store your device in extremely hot areas (such as inside a parked car during the summer). Leaving your device in this environment can cause issues such as leakage or explosion of the internal battery.

Do not use in an environment that requires concentration, or where distraction or sleepiness could cause dangerous situations (for example, but not limited to, driving a car).

Do not store, charge or use your product in or around wet environments or environments with high levels of humidity. Like with any electrical device, there is an electrocution hazard in case the device gets wet.

Do not use or store the device in an environment where use of your device is unauthorized or restricted. This includes areas with flammable materials, fueling areas or any area with a potentially explosive atmosphere, such as areas where the air contains high levels of flammable chemicals, vapours, or particles (such as grains, dust, or metal powders) may be hazardous. Obey all signs and instructions.

Do not expose the device to environments with high external pressures, which could cause internal damage or overheating.

Do not use the device in an environment where there is a possibility to fall more than 70 centimeters / 27.5 inches (for example but not limited to bunk beds, elevated beds or hammocks).

Do not use the device if you notice any unusual smells, smoke or liquids coming from your device or its battery.

# Product specifications

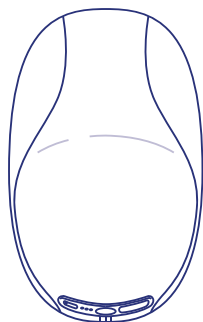

<b>Somnox 2: Breathe &amp; Sleep Robot</b>	
<b>Size (H x W x D)</b>	320 x 210 x 190 mm / 12.6 x 8.3 x 7.5 inches
<b>Weight</b>	1.7 kg / 3.75 lb
<b>Battery type</b>	6800 mAh Li-ion (3.6V)
<b>Compatibility</b>	iOs 10 & Android 4.3 or higher
<b>Connectivity</b>	Bluetooth 4.2 BLE, Bluetooth Classic, Wi-Fi 2.4 GHz
<b>Sensors</b>	Accelerometer, Gyroscope
<b>Memory</b>	4 GB
<b>Rated voltage</b>	5V
<b>Rated power</b>	10 W

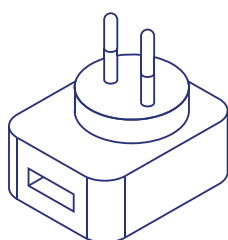

<b>Somnox 2 charger</b>	
<b>Input</b>	100 - 240 V, 50/60 Hz
<b>Output</b>	5V, 2A

# Welcome to the Somnox family

We hope you are excited about your new Somnox 2 Breathe & Sleep Robot. We have designed it to help you relax and improve your night's rest. Before using it, please take a moment to read the instructions and read the complete safety information.

## Take your time to get used to your new sleep companion

Improving sleep is a continuous journey. Give yourself enough time to practice breathing with Somnox 2. It takes about two weeks to become familiar and feel comfortable with your new sleep companion, and it may take three weeks to experience an effect on your sleep quality. We recommend using Somnox 2 in your sleep ritual, starting at least one hour before going to bed so you can unwind after a busy day.

### Timeline

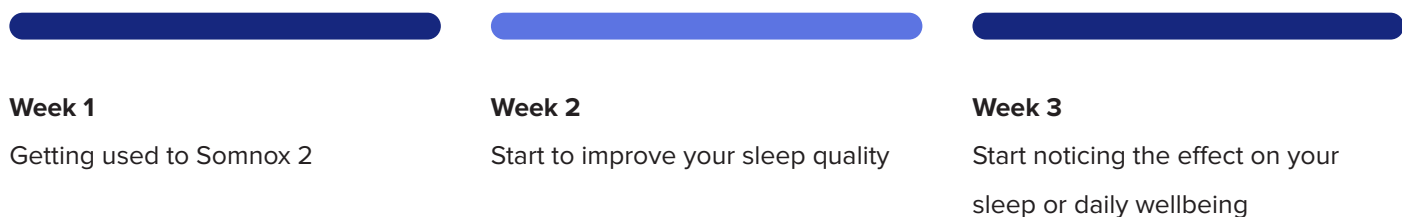



## How does Somnox 2 work?

When you have worrying thoughts or tend to stress easily over things, you can lose control of your breathing. This causes shallow breathing at a high rate, which negatively influences your stress levels. In contrast, slow and deep breathing can positively influence the relaxation of body and mind, which makes it easier for you to fall asleep.

Somnox 2 guides you towards slow breathing. By feeling Somnox 2's breathing movements you will (unconsciously) adapt your own breathing rate to the decreasing breathing rate of the Breathe & Sleep Robot. Slowing down your breathing rate will help you relax more easily.

In addition, Somnox 2 can be an external focus point for your thoughts. Your mind will shift away from the things that keep you awake at night. Somnox 2 can play soothing music, nature sounds, or soft white noise. These sounds may enhance the calming effect of Somnox 2.

# Overview

## What comes with the Somnox 2 package?

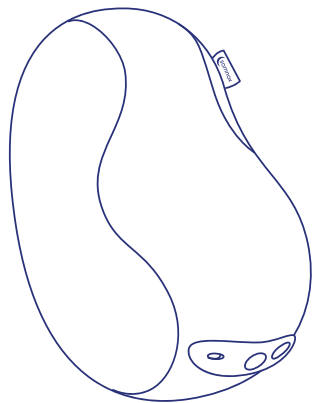

**Somnox 2**

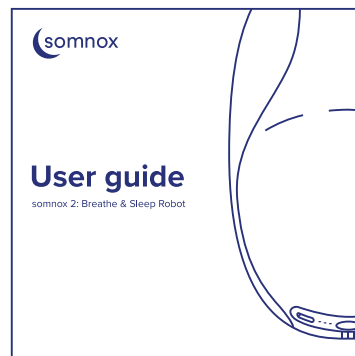

**User manual**

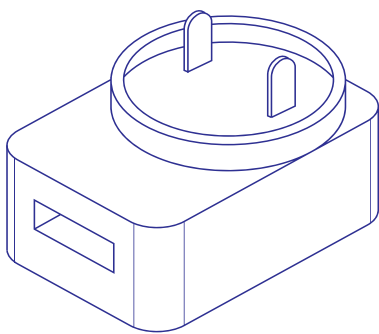

**Charger adapter**

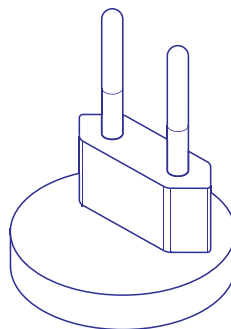

**Charger plug**  
(EU, UK, US)

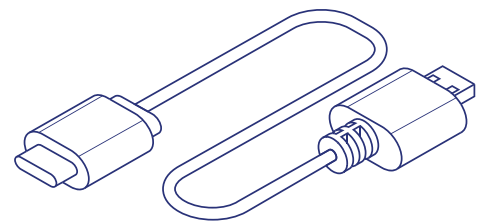

**USB-C cable**

## The Somnox 2

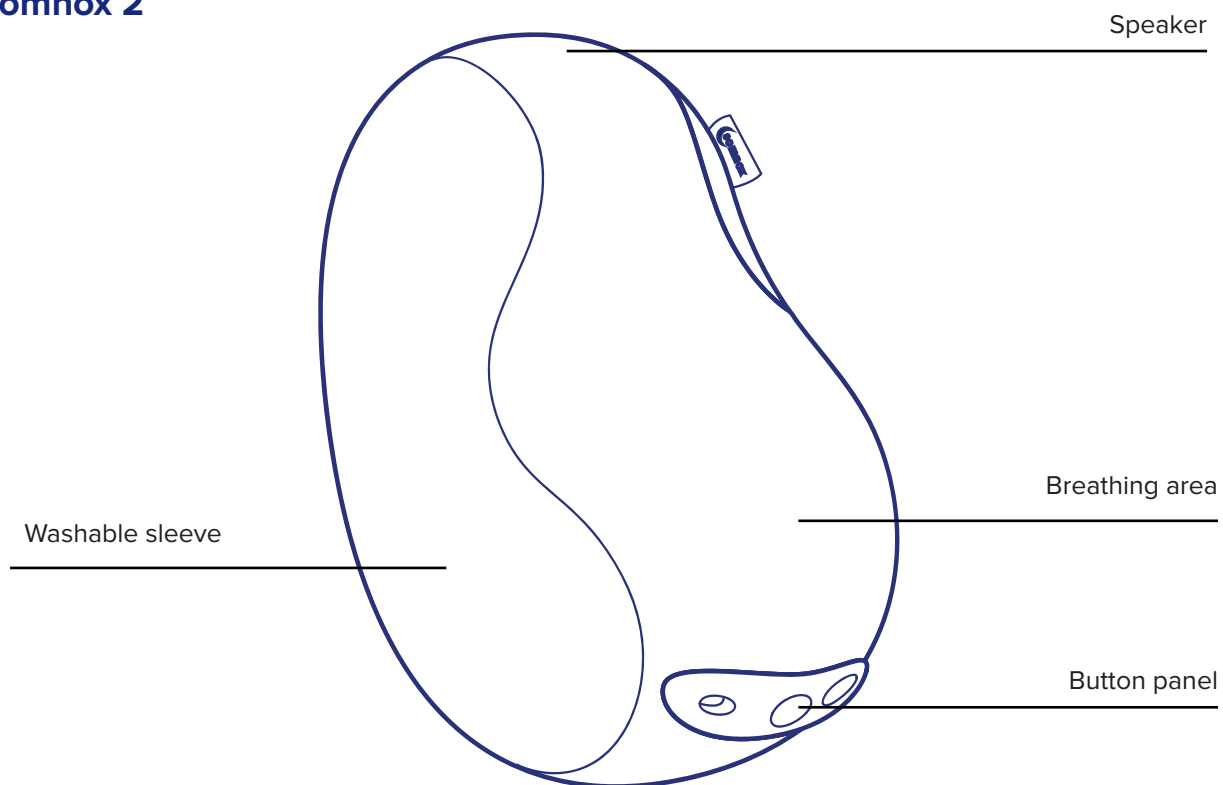

## The Button panel

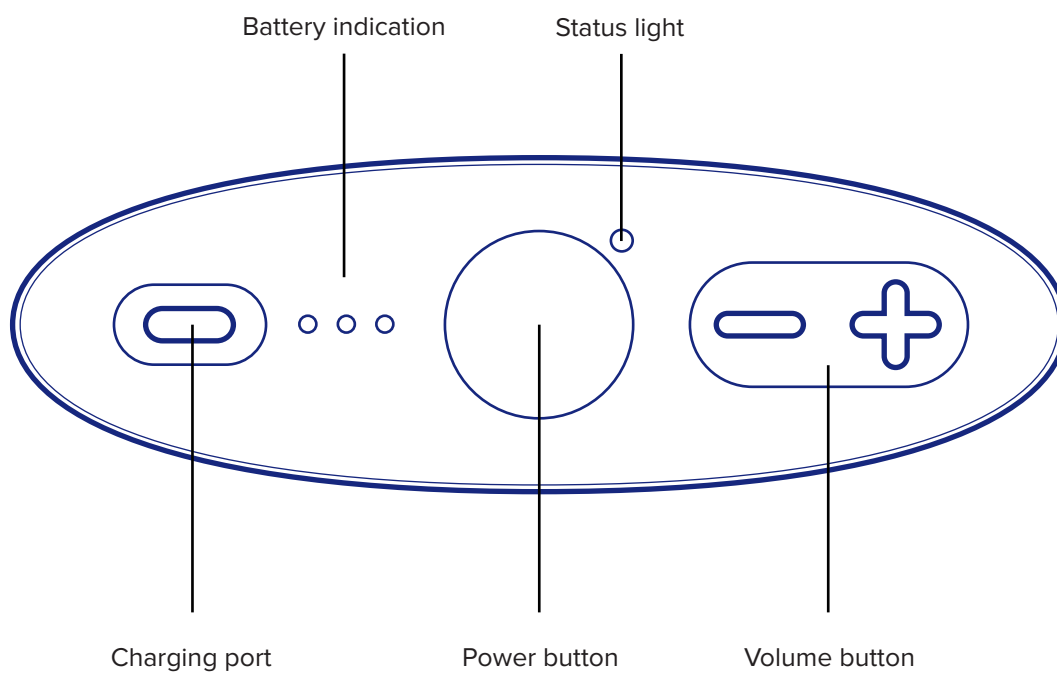

# Getting started

## Charging Somnox 2

We recommend fully charging the battery of your Somnox 2 before using it for the first time. We highly recommend you to only use the Somnox charger for charging. Using other chargers might decrease the charging speed and battery capacity of your Somnox 2.

### Assembling the charger

The charger can be found in a separate box within the packaging of Somnox 2. Within this package you will find a charging adapter, a USB-C cable and plugs for different regions (UK, US, EU). The first step is to assemble the charger. Select the plug of your region and assemble it onto the adapter. The following instructions will help you to do so.

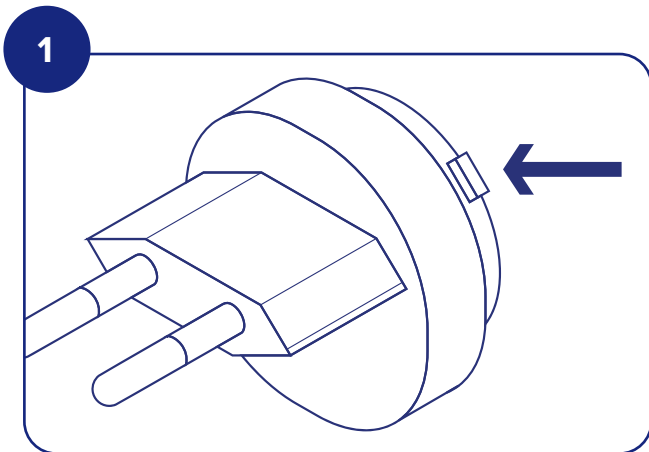

On the back of the plug you will find four protrusions. Locate the top-right protrusion.

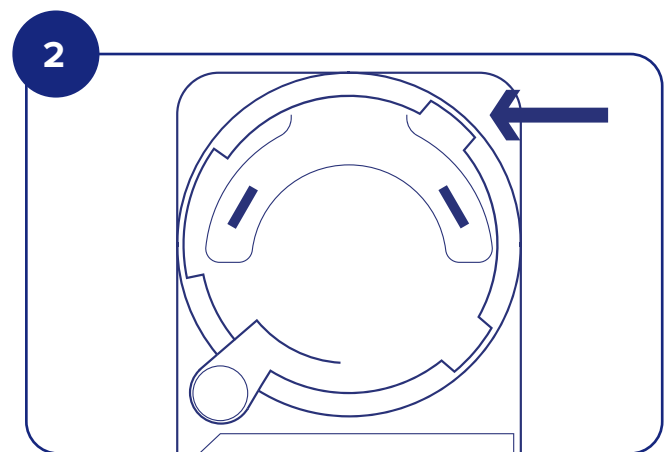

Align the top-right protrusion of the plug, with the top right cut-out of the adapter (see image for clarification).

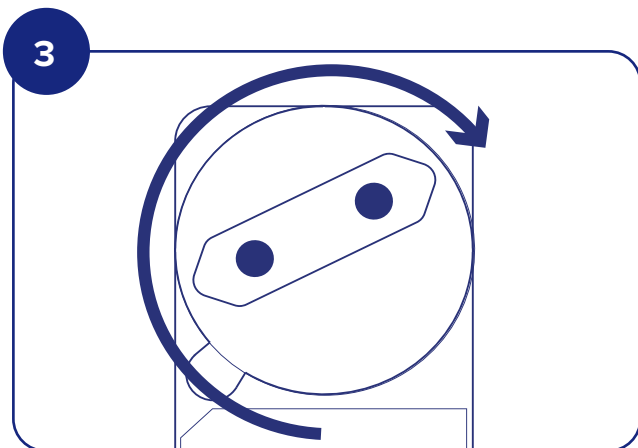

Push the plug into the adapter and turn clockwise to fasten it. You will hear a click.

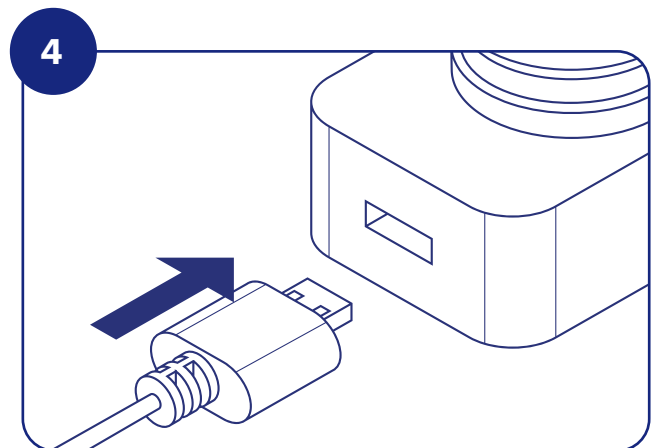

Connect the USB-C cable to the adapter as well.

### Charging Somnox 2

Charge Somnox 2 by inserting the charger plug into the charger port. Push through until you hear a click-sound. Connect the charger to a power source. Once charged, please unplug the charger from the power source and from Somnox 2.

A fully charged Breathe & Sleep Robot will work for several days, depending on the usage. However, we recommend charging Somnox 2 regularly so you can use it whenever you like.

**NOTE:**  
It's not possible to use your Somnox 2 while charging

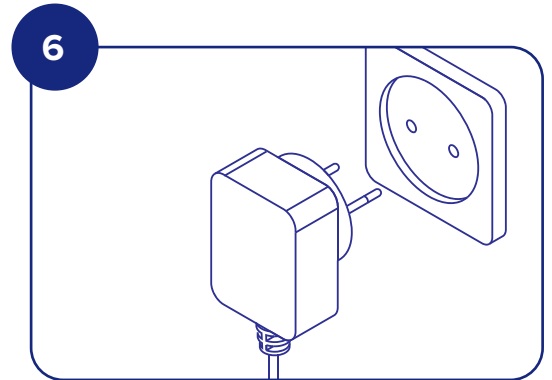
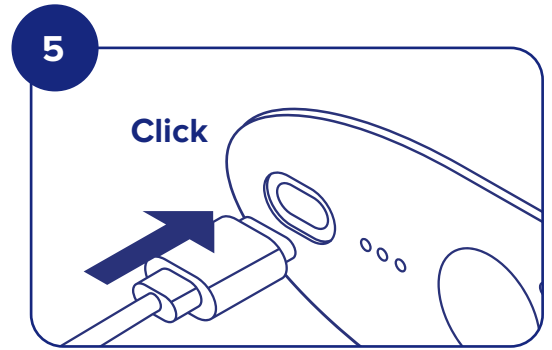

### Battery indication

The battery indicator lights show the charging progress. All three LED lights will light up when fully charged. You can always check the battery level when turning on Somnox 2. Table 1 describes the battery indicator lights.

	Somnox 2 cannot turn on due to insufficient battery charge. Make sure to charge Somnox 2.
	It is possible to use Somnox 2 for at least one session, but you have to charge it soon.
	You do not have to worry about the battery level yet, you can use Somnox 2 for multiple sessions today.
	Somnox 2 is fully charged and will last a couple of days, depending on use.

= Blinking      = light on      = light off

## Basic functionalities

### Turn on your Somnox 2

Once charged, turn on Somnox 2 by pressing the power button on the button panel. If the status light lights up white, Somnox 2 turns on. If it does not light up and one battery indicator blinks, Somnox 2 cannot turn on due to insufficient battery level.

When it has been switched on, Somnox 2 will start breathing. Hold Somnox 2 close to your body and breathe along with the rising and falling sensation of its breathing. Close your eyes and drift away to relaxation.

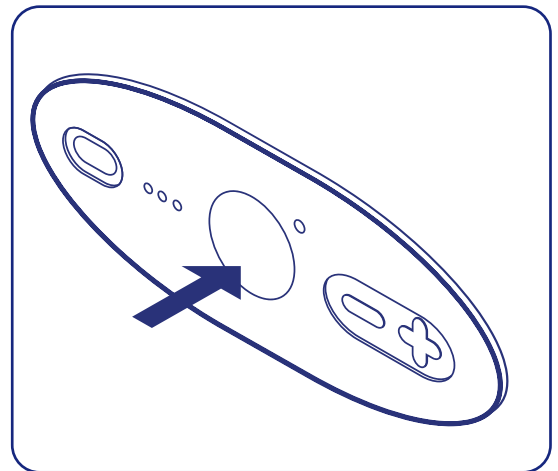

### Turn off your Somnox 2

You can turn off Somnox 2 manually by pressing the power button shortly. A white light on the status light indicates that the Breathe & Sleep Robot is turning off. Its breathing and sound will immediately stop.

If you do not turn off Somnox 2 manually, it will automatically turn off when the breathing program ends. The default program is set to 60 minutes. After 60 minutes the Breathe & Sleep Robot will automatically turn off. You can adjust the duration of the program with the mobile app.

### Controlling the sound

You have the option to play sounds on Somnox 2. The default soundtrack of Somnox 2 is “When the sun sets”. Using the mobile app (which will be explained in the next section) you can select a different soundtrack. These soundtracks are specially crafted to enhance relaxation. Use the button panel to adjust the volume. Press the plus-button shortly to increase sound volume and press the minus-button shortly to decrease sound volume.

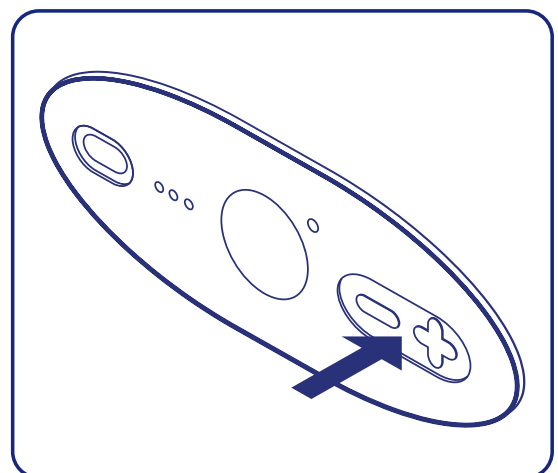

## Download the mobile app

Somnox 2 comes with an app. Using the mobile app you can customise the settings of the Breathe & Sleep Robot to your liking. In the app you can change the breathing settings of Somnox 2, adjust the duration of the breathing program and select your favourite soundtrack.

Secondly, the app provides you with more information about Somnox 2 and gives you additional tips about improving your sleep quality. The mobile app is your personal guide to better sleep and relaxation with Somnox 2.

**Lastly, the app is necessary for updating your Somnox 2, which we will cover in more detail on page 23.**

The app is available in the App store (for iPhone and iPad users) and Google Play (for Android device users). Search for “Somnox” to find the app.



### NOTE:

You do not always need to use the mobile app when using Somnox 2. It is only required for changing settings and updating so you can leave your mobile device outside the bedroom during the night.



# The mobile app

This paragraph provides a comprehensive guide on the basic functionalities of the app. It should be noted that the app will be updated regularly. New features will be added to the app. For the most updated version of its guide please check our knowledge base - <https://somnoxsupport.com/en/>

## Create an account & Sign in

1. Fill in your name. If you prefer not to use your real name, you can use a nickname as well.
2. We will ask you to sign in. You can sign in using your Google account, Facebook account, Apple sign in (only applicable for Apple devices) or make a new account using your email.



### Why do you need to create an account?

1. This allows us to save your custom settings. So for example when you switch to a new phone, you don't need to readjust the settings.
2. This helps us to provide better customer support for you.

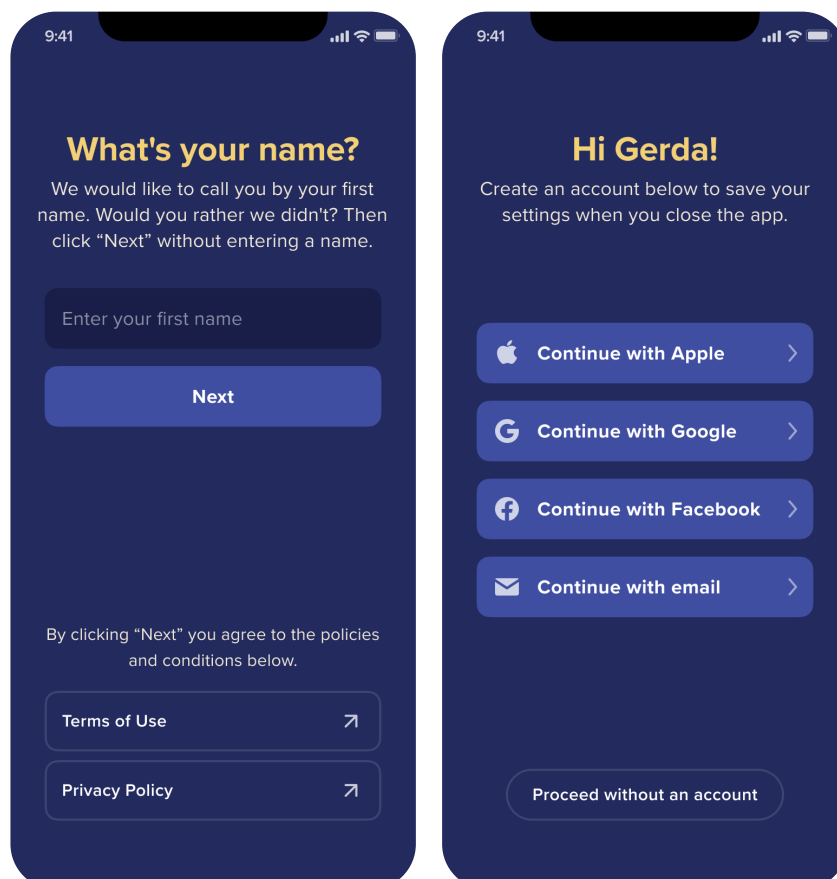

## Connecting your Somnox 2 with the app

1. Turn on the Somnox by pressing the power button briefly.
2. After you have signed in onto the app, the app will ask you to connect to your Somnox. Click on “Connect Somnox”.

**Connect Somnox**

3. To be able for the app to connect to the Breathe & Sleep Robot, you need to have Bluetooth and location services enabled on your phone. Please enable them if you haven't done so already.
4. If the above is all enabled, your phone will start searching for your Somnox. When it is found a Somnox 2 thumbnail will appear on the screen. It might take a couple of seconds before your phone can find your Somnox 2.

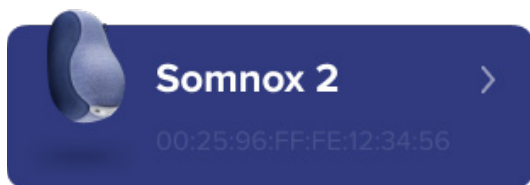

5. Select the Somnox 2 thumbnail. Somnox 2 is now connecting to your phone. This might take a couple of seconds. Please wait patiently.
6. When it's connected the status light on the button panel will blink blue.

## Overview of the app

After you have successfully connected your Somnox 2 with the app, you will now have entered the home screen. The home screen consists of three key elements:

1. Breathing menu
2. Sound menu
3. Status bar

We will go through each of them one by one.

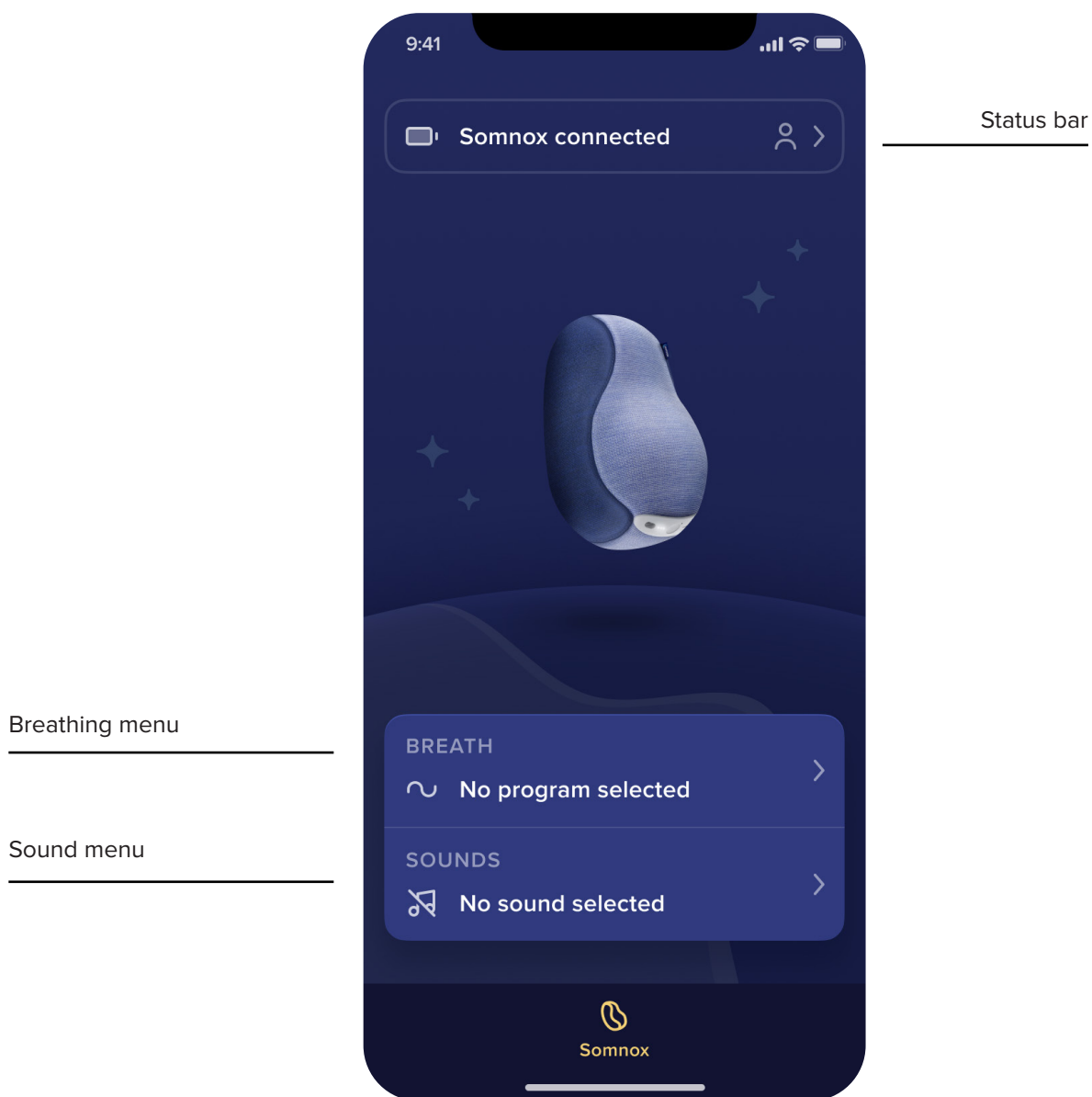

## Breathing-menu

The breathing menu shows the breathing settings that are currently set on the Breathe & Sleep Robot. When using the app for the first time, the breathing menu will be empty. By default, Somnox 2 starts with a breathing rate of 12 breaths per minute. It will slowly guide you to 6 breaths per minute. It has a breathing ratio of 1:2 (meaning that it will exhale twice as long as inhale). The duration of the program is 60 minutes. To adjust these settings you need to create your own breathing program. Tap on the breathing menu. The app will guide you through the process of creating a program. When making your program, you can adjust the breathing rate, the breathing ratio and the duration of the program. We will go through each of these options one by one in more detail.

### Breathing rate

Somnox 2 relaxes your body and mind by guiding you to a slower breathing rate. By default the breathing rate starts at a rate of 12 breaths per minute and gradually decreases to 6 breaths per minute. When changing the breathing rate of the Breathe & Sleep Robot, you first need to change its start rate. We recommend that the start rate matches your own breathing rate. You can discover your rate by counting the number of breaths you take in one minute. Use a stopwatch or timer to support you in this process.



### Somnox Sense

Somnox Sense is a patented feature of Somnox. The Breathe & Sleep Robot has smart sensors that can detect your breathing pattern. When enabling Somnox Sense, your Somnox 2 will automatically select a breathing rate and ratio for you. This means your Somnox 2 will automatically adjust to you.



**NOTE:**

If Somnox Sense is not visible in the app, your Somnox 2 might run on an older software version. Please update your Somnox to enable this feature.

## Breathing ratio

The second parameter you can change is the breathing ratio of your Somnox 2. The breathing ratio is the ratio between the inhalation and the exhalation of each breath. For example a ratio of 1:1 simply means that the inhalation and exhalation are of equal duration. A ratio of 1:2 means that the exhalation is twice as long as the inhalation. A ratio of 1:3 means that the exhalation is three times as long as the inhalation.

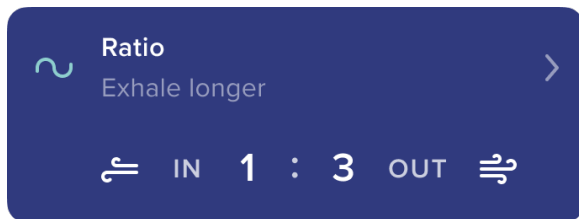

## Duration of the breathing program

Next, you can choose the 'time', in other words, the duration Somnox 2 will breathe. You can set any time from 5 to 120 minutes. When the program ends, Somnox 2 will turn off automatically.



## Breathing exercises

In addition to your breathing programs, you can also select one of our pre-programmed breathing exercises. These are breathing exercises specially designed for a specific goal (such as increasing relaxation, or alertness) and are based on the latest scientific research on breathing and relaxation. Visit [www.somnox.com/research](http://www.somnox.com/research) for more information.

## Sound-menu

The sound menu shows the sound that is currently set on your Somnox 2. Similarly to the breathing menu, the sound menu will be empty the first time you use it. On default the track is set to “When the sun sets”.

To select a different sound, press the sound menu. Next, press on “Somnox music”. This will take you to our list of specially crafted soundtracks.

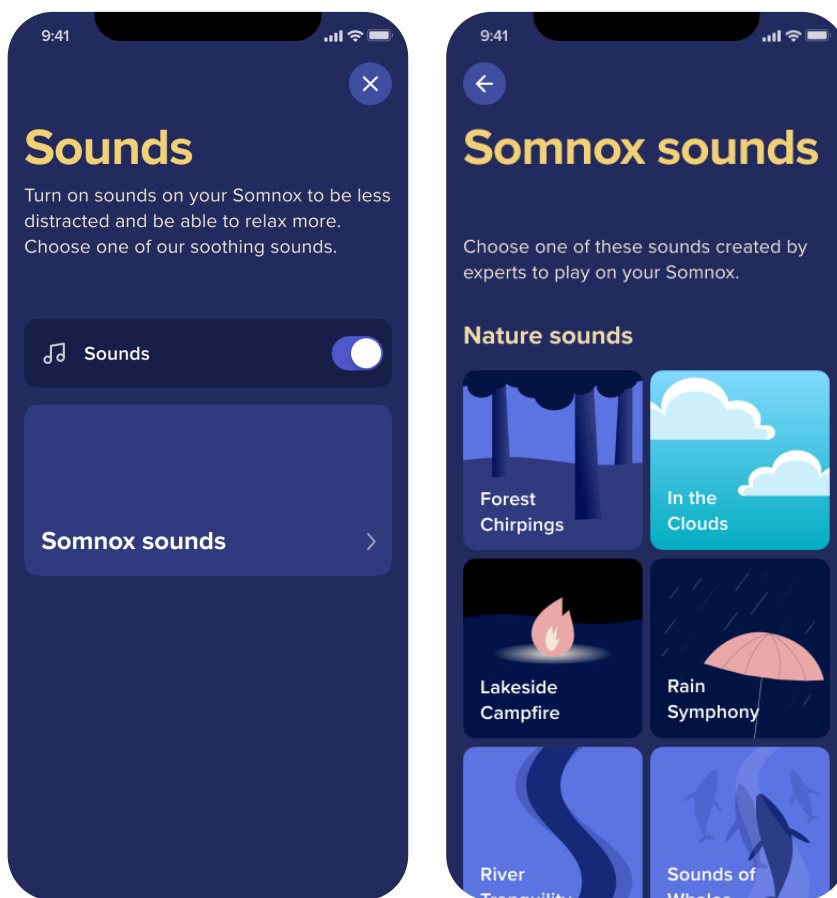

### Status bar

The status bar can be found at the top of the app. When the battery is low, the status bar will indicate that you will have to charge your Somnox 2. Furthermore, when there is an update available, the status bar will suggest you to update your Somnox 2. We will dive more into software updates in the following chapter.



When pressing the status bar you will be taken to the status screen. Here you can see the software your Somnox 2 is running on, its battery percentage, the name you have given to your Somnox 2 and to which Wi-Fi it is connected to.

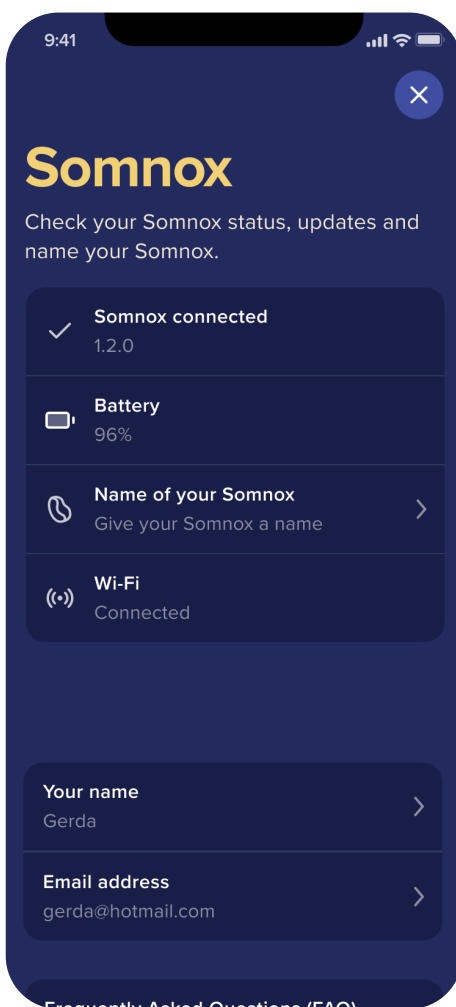

# Updating your Somnox

Your Somnox 2 runs on software. The software controls all the features of your Breathe & Sleep Robot and allows the device to function. We provide updates to improve features, but also to add new features to the device. In this section we provide a complete guide on how to perform a software update.

In order to do a software update you will need to prepare a couple of things:

1. You will need to have Somnox 2 (charged)
2. You will need to have installed the mobile app and it should be connected to your Somnox 2
3. You will need to know your Wi-Fi network and its password

---

## Step 1

Open the app and connect it to your Somnox 2 (for instructions, we would like to refer you to the previous chapter).

## Step 2

When there is an update available it will show on the status bar in the app. Press on the status bar.

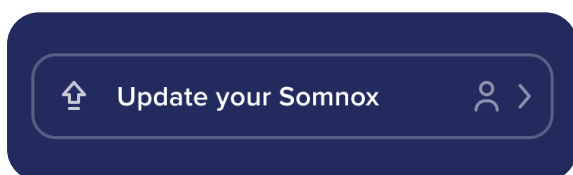

### Step 3

You will be taken to the status screen. Press the top button which says “An update is available”.

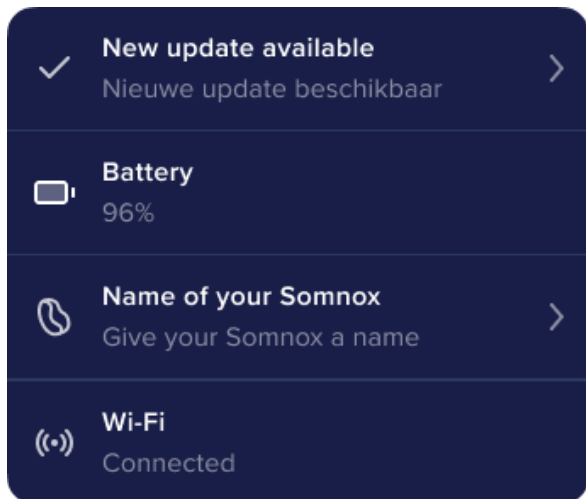

### Step 4

The app will ask you to set up a Wi-Fi connection (if you have not done so already). Please press “Setup Wi-Fi”. The process of setting up Wi-Fi is different for iOS (iPhone or iPad) and Android devices. We will first discuss the Wi-Fi setup for iOS devices. Please visit page 26 for the instructions for Android devices.



**NOTE:**

Somnox 2 can only connect to 2.4 GHz Wi-Fi.  
Please go to page 27 for more information.

## Setting up Wi-Fi for iOS

### Step 4.1

After pressing “Set up Wi-Fi”, you will be asked to give permission for the app to access your location services. Please give the app permission.

### Step 4.2

You will then be asked to fill in the name and password of your Wi-Fi. The app automatically fills in the name of the Wi-Fi network your phone is currently connected to. It should be noted that Somnox 2 is not compatible with 5.0 GHz networks.

An easy way to spot whether you have a 5.0 GHz network, is to look at the name of the Wi-Fi. 5.0 GHz networks typically have a 5, 5G or 5.0G in the name. If that is the case, please identify the name and password of your 2.4 GHz network. For more information, please go to page 27, where we will explain this in more detail.

After you have filled in the password and name, press “Set to Somnox”. You have now successfully connected Somnox 2 with your Wi-Fi!

**Continue on page 28 for the next steps**

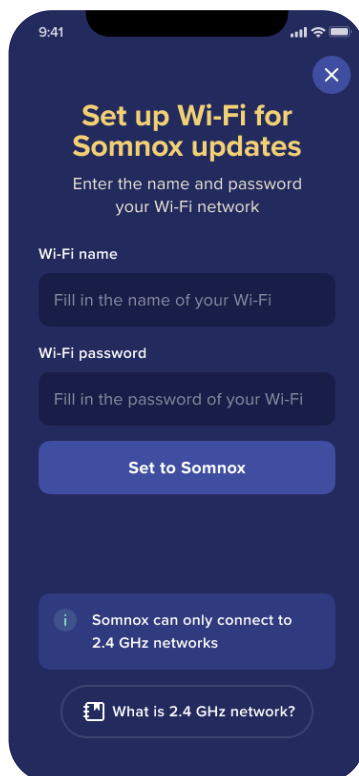

## Setting up Wi-Fi for Android

### Step 4.1

A screen will pop up with all the available Wi-Fi networks your Somnox 2 can connect to. Select your Wi-Fi network and fill in the password if you have one. Somnox 2 is now successfully connected to Wi-Fi. Please mind that Somnox 2 is only compatible with 2.4 GHz networks. You will find more information about this on page 27.

**Continue on page 28 for the next steps**

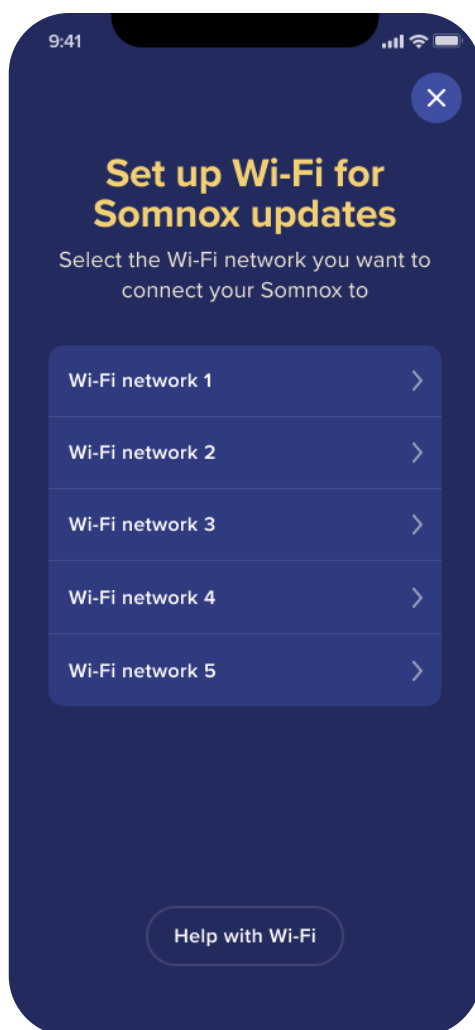

## What is 2.4 GHz Wi-Fi?

We will spare you the technical details. The only important thing to understand is that there are two types of Wi-Fi networks. 2.4 GHz networks and 5.0 GHz networks.

All Wi-Fi routers have a 2.4 GHz network. However, newer routers can also have a 5.0 GHz network. They have both. Unfortunately, Somnox 2 is not compatible with 5.0 GHz networks.

## How do you know whether you have a 2.4 or 5.0 GHz network?

The easiest way to check this is to go to the Wi-Fi settings on your phone and scan for available Wi-Fi networks. Do you have two Wi-Fi networks that belong to your home, but you only have one router? In that case, you likely have a newer router that has a 5.0 GHz and a 2.4 GHz network.

If you only have a single network that belongs to your home, then it's likely that it is a 2.4 GHz network. You can then proceed without any problems.

In case you have two networks, the name of the Wi-Fi network typically indicates whether it is 5.0 GHz or 2.4 GHz. A 2.4 GHz network typically includes a 2.4G, 24G, 24 or 2 in its name. A 5.0 GHz network typically includes a 5.0G, 5G or 5 in its name. For example:

YourRouterName\_5.0G\_WiFi

YourRouterName\_2.4G\_WiFi

YourWiFi\_5G

YourWiFi\_24G

YourNetwork5

YourNetwork2

We understand that this may seem a bit technical. In case you find yourself struggling with connecting your Wi-Fi please visit our knowledge base or contact our customer support. We are happy to help you.

### Step 5

Press the update button to start updating your Somnox. While updating, the status light on the button panel will show a shimmering blue light. The update may take a few minutes. In the meantime you cannot use your Somnox 2.

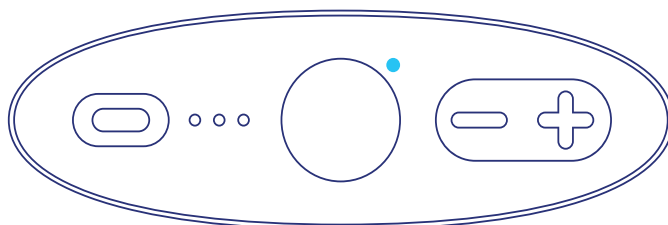

### Step 6

When the update is completed, Somnox 2 will automatically restart. When that happens, press "Okay".



### Step 7

Finish the update by reconnecting the app to your Somnox 2. After reconnection, a pop-up should appear saying that Somnox has been updated successfully. (It might take a couple of seconds before the pop-up appears.)

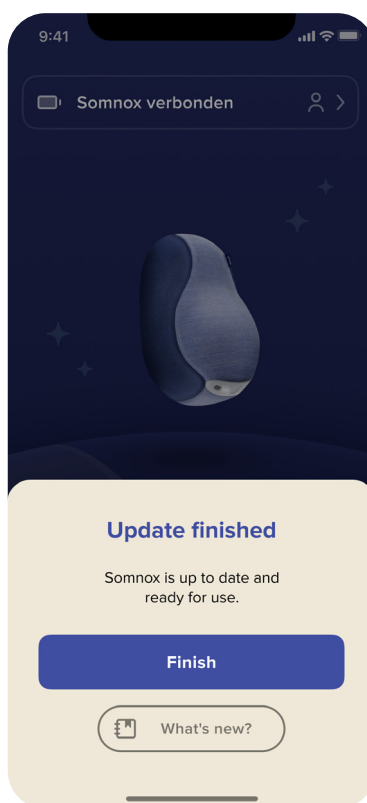
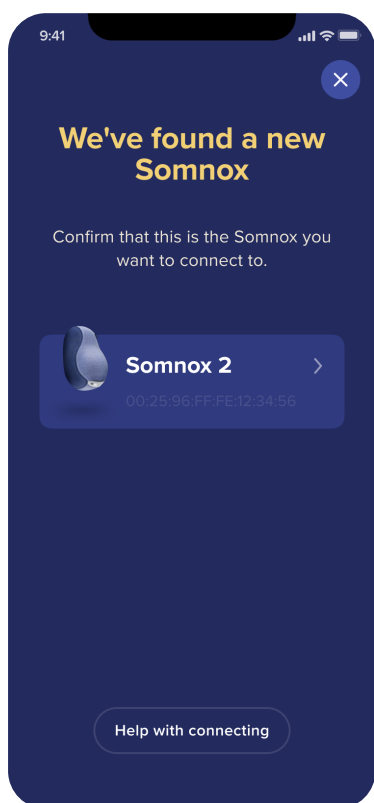

# Sleeping with your Somnox 2

## Preparing for bed

To prepare Somnox 2 for use, make sure the battery is sufficiently charged. We recommend using Somnox 2 as part of your bedtime ritual, starting about one hour before going to bed, so you can wind down after a busy day. Try to adhere to a consistent sleep routine, wherein you can keep the following tips in mind:

1. One to two hours before going to bed, dim the lights in your home environment. Don't use any electronic devices with screens in this time before going to bed, since their light and notifications keep you alert.
2. Go to bed and wake up at the same time every day. This will help your body and mind to get used to a certain day-night ratio, leading to faster sleep onset and easier wake up.
3. Do a breathing exercise or take a moment of relaxation with your Somnox 2 before going to bed. Being calm before going to bed has a positive effect on your sleep onset and sleep quality.



## Sleeping positions

The best way to sleep with Somnox 2 is in whatever position feels comfortable for you. There is no specific position that works for everyone. To feel (and/or hear) the breathing movement, you can either position the breathing towards your body, or just place your hand on it. We recommend you to experiment and try to find out what feels comfortable for you. You'll find some examples of sleeping positions below.



---

## Midnight awakening

When you wake up during the night or early in the morning, you can simply turn on Somnox 2 by pressing the power button. It will recommence the program as set via the mobile app and automatically turn off when the program ends. If you want to turn off the sound during the night, you can turn the sound volume to zero by briefly pressing the minus button multiple times, until you don't hear the sound anymore.

## Tips for using your Somnox 2

### Using sound for sleep onset

You can use the provided soundtracks to create a calm ambience without any other distractions. Some sound settings that might help you:

1. Are you quickly bothered by noise from the environment or Somnox 2's mechanism? Use 'white noise', which works as a noise filter.
2. Exercise: set nature sounds to your Somnox 2. While listening, imagine you are walking in a green forest. Focus on your breath and adapt to the ratio of inhaling and exhaling as you are imaginarily walking through this forest.

### Focussing on the breathing motion vs. unconsciously slowing down your breath

There are different ways of using Somnox 2: either focus on the breathing movement (which protects your mind from racing thoughts) or unconsciously let your breath synchronize with Somnox 2.

If you find it hard to follow the breathing movement of Somnox 2, try not to focus too much on the Breathe & Sleep Robot itself. Instead, you can try to focus on your own breathing rate, or distract your mind by listening to music or a guided meditation.

### Turning Somnox 2 on another time

It is possible that sometimes you won't fall asleep within the set duration of the breathing program. It is up to you whether you want to turn it on a second time by pressing the power button (it will recommence the set program) or not. You can also try to focus on your own breath until you fall asleep.

# Use your Somnox 2 during the day

Did you know that you can also use Somnox 2 during the day? Take your Somnox 2, have a seat or lie down and relax. Relaxing moments during the day reduce your stress level, which can have a positive effect on your sleep quality during the night. There are several ways and reasons to use your Somnox 2 during the day:

## To get used to Somnox 2

When Somnox 2 is new to you, we recommend using it during the day to get familiar with it. Experiment with the settings via the mobile app, try out different sounds and practice following the breathing movement. This way, it becomes easier to adapt to using Somnox 2 at night.

## Experiment with settings

Especially during the first weeks, you might grope in the dark about the right settings that feel comfortable to you. We recommend that you experiment with this during the day, instead of during the night. This way, you avoid undesired stimuli from your phone and the hassle of thinking about other settings. If the breathing settings do not totally satisfy your needs, put Somnox 2 away or try to focus on something else. You can try again later or ask the Somnox crew for help. We are happy to help.

## Breathing exercises

Many of us take shallow, incomplete breaths as we go throughout the day - and we extend this ineffective breathing into the night. At first, it seems difficult to breathe in a more natural and healthy way, but it is something you need to practice. Somnox 2 can help you via the breathing exercise programs available in the mobile app. Doing a 10-minute breathing exercise every day can help you calm down and improve your way of breathing.

## Increase the effect on your sleep by relaxation during the day

There is a Dutch saying about the night being the 'mirror' of the day. What you do during the day affects your sleep quality, even if you think you are quite relaxed in the evening. We recommend becoming more aware of your stress levels during the day and taking a couple of moments for yourself. Somnox 2 can help you with this. Take a moment to do a breathing exercise with your Somnox 2 to wind down.

## Calm start of the day

Have you thought about using Somnox 2 in the morning? Take 10 minutes to sit down with your Somnox 2 for a short meditation session, to start the day with a peaceful and conscious mind. Close the session with some stretching.

## Cleaning your Somnox 2

As you're sleeping with your Somnox 2, we can imagine that you want your Somnox 2 to stay clean. Follow the subsequent steps to clean your Somnox 2. In case of uncertainties or questions please contact us. Never expose your Somnox 2 to a humid or wet environment, and never place it in a washing machine, as this will cause malfunction of Somnox 2 or injury to yourself. Always follow the guidelines in this manual.

### Washable sleeve

The blue sleeve can be easily removed from Somnox 2. Open the zipper on the back of Somnox 2, and carefully remove the sleeve. The sleeve can be machine washed. However, this should be done with care. Please follow the guidelines below.

#### Important:

1. **Never wash the sleeve with Somnox 2 inside.**
2. **The sleeve can be washed at a max. temperature of 30°C or 86°F (●●).**
3. **Do NOT machine dry the sleeve. Dry it naturally in open air.**
4. **Wash the sleeve inside out with the zipper closed.**
5. **We recommend you to use a laundry bag for washing the sleeve, as this will extend the lifespan of the sleeve.**



### Lint and pilling

There is a possibility that lint and pilling will appear on the sleeve after washing it a few times. You can minimize this by washing the sleeve inside out with the zipper closed, and preferably wash it within a laundry bag. You can use a lint brush or lint remover to remove the lint and pilling if it still appears.

## Putting on the sleeve around Somnox 2

1. It's easiest to put the fabric around the button panel first.
2. Then pull the sleeve around the top of Somnox 2.
3. Then wrap the sleeve around the bottom and close the zipper.

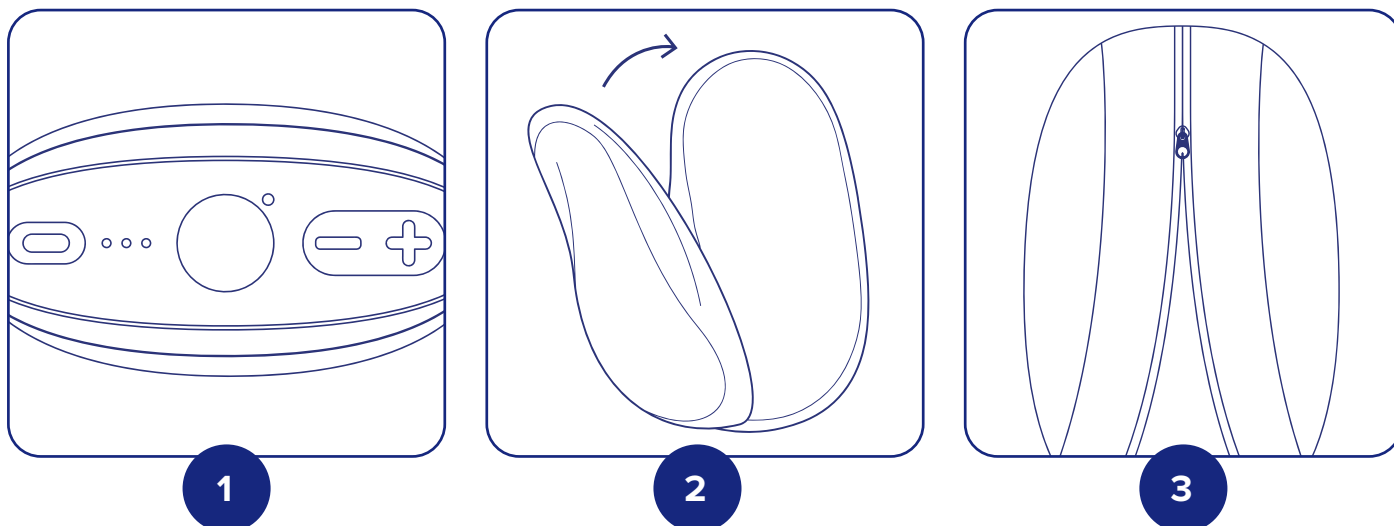

## Cleaning the button panel

If there is any dirt or moisture on the button panel you can wipe it off with a dry cloth. **Do not use a damp or wet cloth to clean the button panel. Don't use chemical cleaning products. Do not put any other object (e.g. a screwdriver or pencil) in the USB-C charger port besides the provided charger.**

## Drying your Somnox 2

Try to keep your Somnox 2 dry. Whenever your Somnox 2 gets wet, gently try to pat it dry with a dry cloth. Let it air-dry. Do not machine dry Somnox 2, the foam layer or the fabrics. Please contact our customer support for advice via [info@somnox.com](mailto:info@somnox.com) or other contact details.

# Troubleshooting

It might happen that your Somnox 2 does not behave like it is supposed to. For example: it cannot be turned on anymore, or it does not react to certain commands. In that case you can try restoring your Somnox 2 to its factory settings.

To do this, please press all the buttons on the button panel for 10 seconds. Make sure that you press all buttons well. You should be able to feel a subtle click.

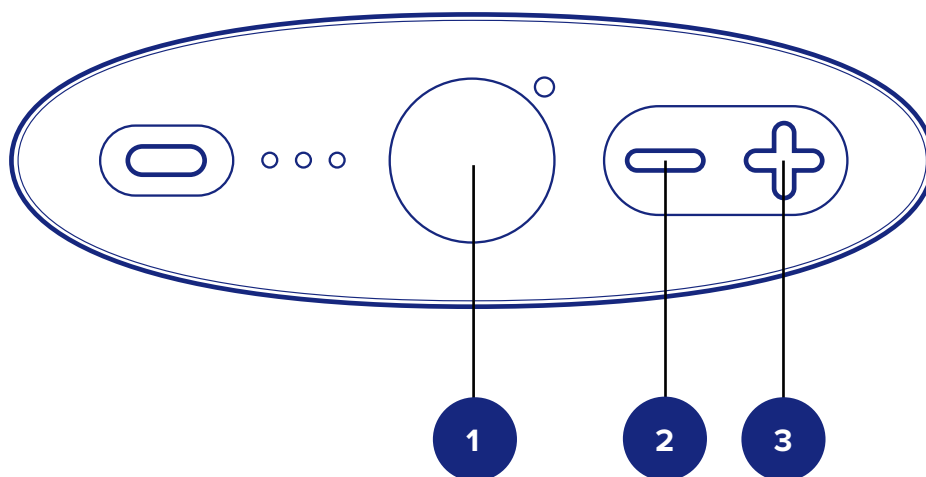

If done correctly your Somnox 2 should restart. **Please update your Somnox 2 using the app, as you have now restored it to an older software version.**

## Contact information

Do you need help? Visit our knowledge base. Here you will find detailed Somnox 2 instructions and answers to the most frequently asked questions. Prefer to talk to someone? Feel free to contact us via the chat in the app or call or email us using the contact details below. We'll be happy to help!



### Support

[somnoxsupport.com](https://www.somnoxsupport.com)



### E-mail us

[info@somnox.nl](mailto:info@somnox.nl)



### Call us

+31 10 8994105 (NL)



### Chat with us

Chat with us through the app or website



### Headquarters

Stationsplein 45 A4.004  
3013AK Rotterdam  
The Netherlands

## Feedback

We are very excited to hear about your experience with Somnox 2. Please let us know so we can further improve. Let us know at [feedback@somnox.com](mailto:feedback@somnox.com).



### Want to share your experience?

Leave a review at  
[www.trustpilot.com/review/meetsomnox.com](https://www.trustpilot.com/review/meetsomnox.com).

# Certifications



This marking indicates that this product should not be disposed with other household wastes throughout the EU. To prevent possible harm to the environment or human health from uncontrolled waste disposal, recycle it responsibly to promote the sustainable reuse of material resources. To return your used device, please use the return and collection systems or contact the retailer where the product was purchased. They can take this product for environmental safe recycling.



Hereby, Somnox B.V. declares that the radio equipment type Somnox 2 Sleep Robot is in compliance with Directive 2014/53/EU. The full text of the EU declaration of conformity is available at the following internet address: [www.somnoxsupport.com/certification](http://www.somnoxsupport.com/certification).



This equipment has been tested and found to comply with the limits for a Class B digital device, pursuant to Part 15 of the FCC Rules. These limits are designed to provide reasonable protection against harmful interference in a residential installation.

This equipment generates, uses and can radiate radio frequency energy and, if not installed and used in accordance with the instructions, may cause harmful interference to radio communications. However, there is no guarantee that interference will not occur in a particular installation. If this equipment does cause harmful interference to radio or television reception, which can be determined by turning the equipment off and on, the user is encouraged to try to correct the interference by one of the following measures:

Reorient or relocate the device.

Connect the equipment into an outlet on a circuit different from that to which the receiver is connected.

Contact Somnox for help.

To assure continued compliance, any changes or modifications not expressly approved by the party responsible for compliance could void the user's authority to operate this equipment.

This device complies with Part 15 of the FCC Rules. Operation is subject to the following two conditions:

This device may not cause harmful interference, and

This device must accept any interference received, including interference that may cause undesired operation.



This device complies with Industry Canada licence-exempt RSS standard(s). Operation is subject to the following two conditions:

1. this device may not cause interference and
2. this device must accept any interference, including interference that may cause undesired operation of the device

Le présent appareil est conforme aux CNR d'Industrie Canada applicables aux appareils radio exempts de licence. L'exploitation est autorisée aux deux conditions suivantes :

1. l'appareil ne doit pas produire de brouillage, et
2. l'utilisateur de l'appareil doit accepter tout brouillage radioélectrique subi, même si le brouillage est susceptible d'en compromettre le fonctionnement.

